 **Whirlpool Gold[®]**



THREE SPEED ELECTRONIC WASHER

Use & Care Guide

For questions about features, operation/performance, parts, accessories or service call: **1-800-253-1301**

In Canada, for assistance call: **1-800-461-5681**,
for installation and service call: **1-800-807-6777**

or visit our website at
www.whirlpool.com or **www.whirlpool.com/canada**

Table of Contents.....2

TABLE OF CONTENTS

WASHER SAFETY	3
PARTS AND FEATURES	4
WASHER USE	5
Understanding Washer Cycles	5
Loading	5
Normal Sounds	5
Starting Your Washer	6
Changing or Cancelling Cycles and Options	7
Selecting a Cycle	8
Selecting Options	9
ACCUWASH™ Temperature Control System	9
SMART BLEACH™ Timed Bleach Dispenser	10
Self-Cleaning Lint Filter	10
WASHER CARE	10
Cleaning Your Washer	10
Water Inlet Hoses	10
Vacation, Storage, and Moving Care	10
TROUBLESHOOTING	11
ASSISTANCE OR SERVICE	14
WARRANTY	16



WASHER SAFETY

Your safety and the safety of others are very important.

We have provided many important safety messages in this manual and on your appliance. Always read and obey all safety messages.



This is the safety alert symbol.

This symbol alerts you to potential hazards that can kill or hurt you and others.

All safety messages will follow the safety alert symbol and either the word "DANGER" or "WARNING." These words mean:

⚠ DANGER

You can be killed or seriously injured if you don't immediately follow instructions.

⚠ WARNING

You can be killed or seriously injured if you don't follow instructions.

All safety messages will tell you what the potential hazard is, tell you how to reduce the chance of injury, and tell you what can happen if the instructions are not followed.

IMPORTANT SAFETY INSTRUCTIONS

WARNING: To reduce the risk of fire, electric shock, or injury to persons when using the washer, follow basic precautions, including the following:

- Read all instructions before using the washer.
- Do not wash articles that have been previously cleaned in, washed in, soaked in, or spotted with gasoline, dry-cleaning solvents, other flammable, or explosive substances as they give off vapors that could ignite or explode.
- Do not add gasoline, dry-cleaning solvents, or other flammable, or explosive substances to the wash water. These substances give off vapors that could ignite or explode.
- Under certain conditions, hydrogen gas may be produced in a hot water system that has not been used for 2 weeks or more. **HYDROGEN GAS IS EXPLOSIVE.** If the hot water system has not been used for such a period, before using the washing machine, turn on all hot water faucets and let the water flow from each for several minutes. This will release any accumulated hydrogen gas. As the gas is flammable, do not smoke or use an open flame during this time.
- Do not allow children to play on or in the washer. Close supervision of children is necessary when the washer is used near children.
- Before the washer is removed from service or discarded, remove the door or lid.
- Do not reach into the washer if the drum, tub or agitator is moving.
- Do not install or store the washer where it will be exposed to the weather.
- Do not tamper with controls.
- Do not repair or replace any part of the washer or attempt any servicing unless specifically recommended in this manual or in published user-repair instructions that you understand and have the skills to carry out.
- See "Electrical Requirements" for grounding instructions.

SAVE THESE INSTRUCTIONS

PARTS AND FEATURES

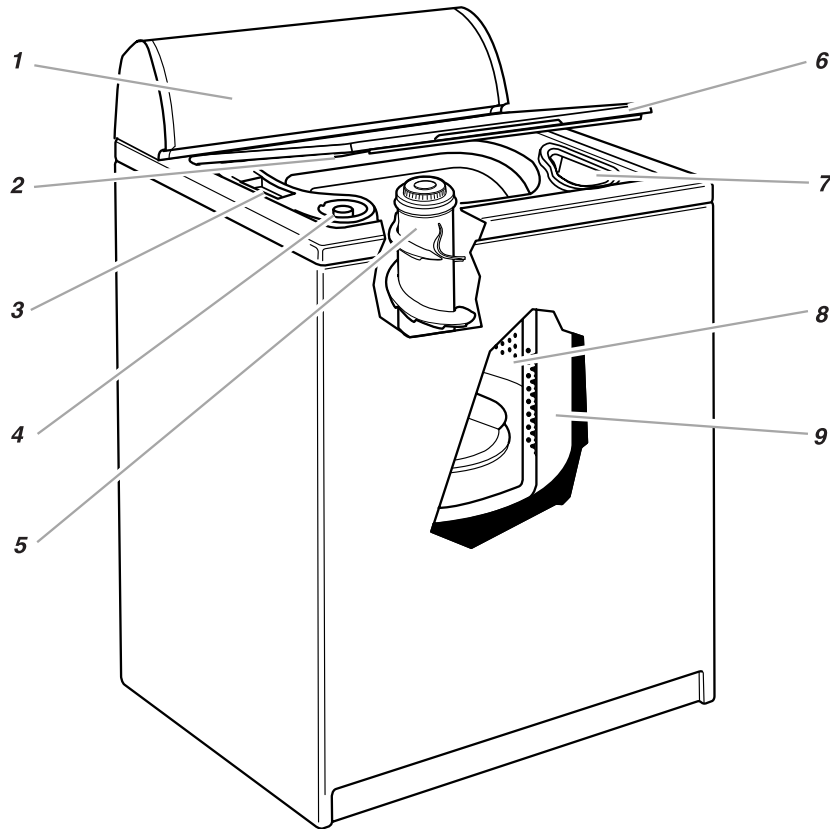

- 1. Control panel
- 2. Model and serial number label
- 3. Liquid chlorine bleach dispenser
- 4. Liquid fabric softener dispenser
- 5. XTRA ROLL ACTION™ PLUS agitator
- 6. Lid

- 7. Detergent dispenser
- 8. DURASMOOTH™ white porcelain basket
- 9. Tub

Additional features

CATALYST® cleaning action
 ACCUWASH™ temperature control system

Control panel

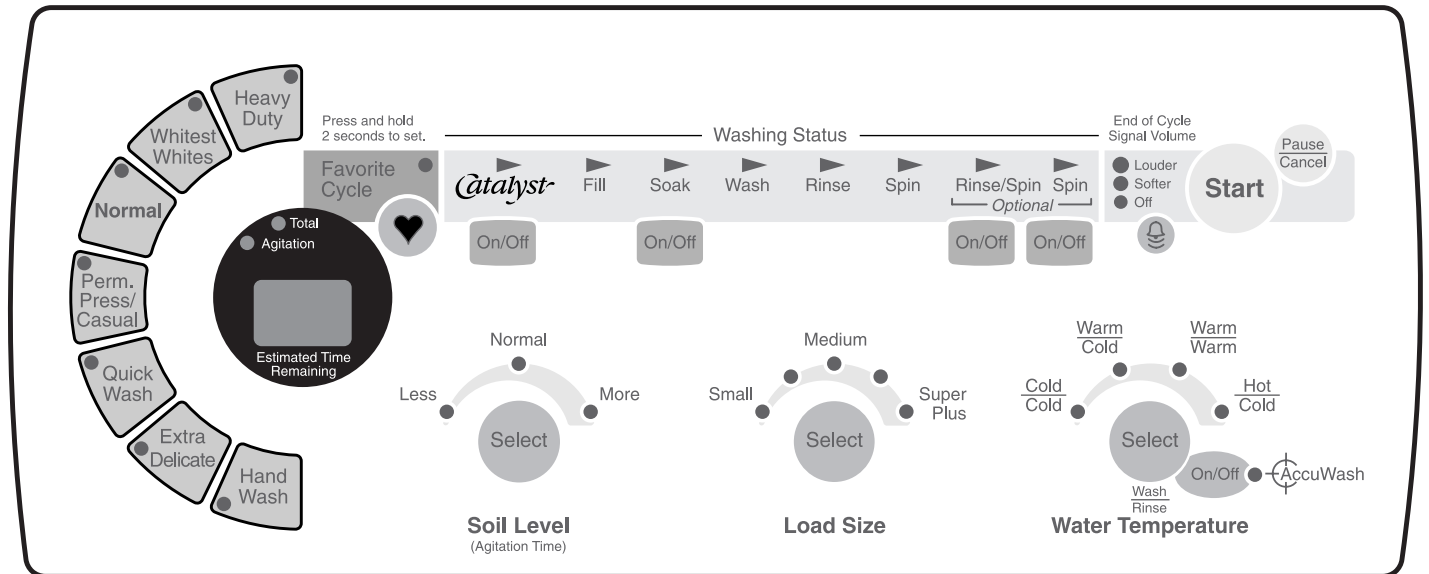

WASHER USE

Understanding Washer Cycles

When a cycle is selected, the washer lid is closed, and Start is pushed, the washer fills (to the selected load size) before agitation and timing start. The washer begins agitating immediately after filling. If CATALYST® cleaning action is selected, the washer spins and sprays detergent solution for a brief period before filling with water.

During agitation, the agitator creates a continuous rollover action that provides a thorough cleaning of the wash load.

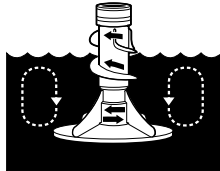

NOTES:

- The washer pauses briefly throughout each cycle. These pauses are normal for washer operation.
- Follow the progress of your wash cycle with the Washing Status indicator lights.

WASH

RINSE



1. Spin-Spray (detergent mixture)[†]



1. Fill



2. Fill



2. Rinse



3. Wash selected time



3. Drain
No agitation



4. Drain
No agitation*



4. Spin-Spray
rinse



5. Spin



5. Spin

[†] When the CATALYST option is selected, the washer spins and sprays a detergent solution for a brief period prior to filling.



6. Off

* The Permanent Press/Casual cycle partially drains, fills, agitates briefly, and drains.

Loading

Loading suggestions

For these suggested full-sized loads, set the LOAD SIZE selector to the highest setting.

SUPER CAPACITY PLUS WASHERS

Heavy Work Clothes

3 pair pants	1 coverall
3 shirts	1 overall
4 pair jeans	

Delicates

3 camisoles	6 undergarments
1 quilted robe	2 sets of sleepwear
4 slips	1 child's outfit

Towels

10 bath towels	14 wash cloths
10 hand towels	1 bath mat

Mixed Load

3 double sheets	2 shirts
4 pillowcases	2 blouses
8 T-shirts	8 handkerchiefs
6 pair shorts	

Normal Sounds

Your new washer may make sounds your old one didn't. Because the sounds might be unfamiliar, you may be concerned about them. These sounds are normal.

During washing

When you select a small load size setting, your washer has a lower water level. This can cause a clicking sound from the upper part of the agitator.

If you select CATALYST® cleaning action, you will hear a spin/spray noise at the start of the cycle.

During drain

If water is drained quickly from your washer (depending on your installation), you may hear air being pulled through the pump during the end of draining.

After drain and before spin

When the cycle changes from draining to spinning, you may hear gears engaging.

When selecting a cycle or an option

A tone sounds whenever a selection is made. The sound level of the tones is not adjustable.

- A single tone sounds whenever a selection is accepted.
- Three short tones sound if an unavailable selection is made.

Starting Your Washer

⚠️ WARNING



Fire Hazard

Never place items in the washer that are dampened with gasoline or other flammable fluids.

No washer can completely remove oil.

Do not dry anything that has ever had any type of oil on it (including cooking oils).

Doing so can result in death, explosion, or fire.

⚠️ WARNING



Electrical Shock Hazard

Plug into a grounded 3 prong outlet.

Do not remove ground prong.

Do not use an adapter.

Do not use an extension cord.

Failure to follow these instructions can result in death, fire, or electrical shock.

- Drop a load of sorted clothes loosely into the washer.
 - Load evenly to maintain washer balance. Mix large and small items.
 - Items should move easily through the wash water. Overloading can cause poor cleaning.
 - To reduce wrinkling of permanent press clothes and some synthetic knits, use a large load size to provide more space (see step 6).
- Pour measured powdered or liquid detergent into the detergent dispenser.



- Pour measured liquid chlorine bleach into the liquid chlorine bleach dispenser, if desired. Bleach is diluted and automatically dispensed during the wash cycle. See “SMART BLEACH™ Timed Bleach Dispenser.”

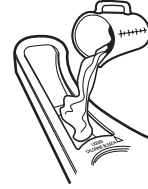

- Never use more than 1 cup (250 mL) for a full load. Use less for a smaller load size.
 - Follow the manufacturer’s directions for safe use.
 - To avoid spilling, use a cup with a pouring spout. Do not let bleach splash, drip, or run down into the washer basket.
 - Use only liquid chlorine bleach in this dispenser.
- Pour measured liquid fabric softener into the fabric softener dispenser, if desired.

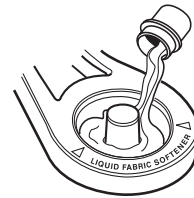

- Do not overfill. The dispenser holds 3 oz (94 mL), or a standard capful of fabric softener.
 - The fabric softener is dispensed in the final rinse.
 - Do not spill or drip any fabric softener on the clothes.
 - Use only liquid fabric softener in this dispenser.
- Close the washer lid.
 - Select a Cycle. The preset Soil Level, Load Size, and Water Temperature for the selected cycle will glow. See “Selecting a Cycle.”
 - The preset settings provide the recommended fabric care for your selected cycle.
 - You can change the preset settings by pressing the “Select” pad of each option until the desired setting glows.

Select

- Your washer uses ACCUWASH™ temperature control system. When you select a cycle, the washer selects the recommended ACCUWASH setting for the type of fabric and soils being washed. See “ACCUWASH Temperature Control System.” For best fabric care, follow garment label instructions. See the Temperature Guide for more information.

Temperature Guide

Water Temp	Use For
Hot 111°F (44°C) or above	Whites and pastels Heavy soils
Warm 90°-110°F (32°-43°C)	Bright colors Moderate to light soils
Cold 70°-90°F (21°-32°C)	Colors that bleed or fade Light soils

NOTE: In wash water temperatures colder than 70°F (21°C), detergents do not dissolve well. Soils can be difficult to remove. Some fabrics can retain wear wrinkles and have increased pilling (the formation of small lint-like balls on the surface of garments).

7. (OPTIONAL STEP) To select or cancel CATALYST® cleaning action, press On/Off. To learn how CATALYST cleaning action works, see “Selecting Options.”



- CATALYST cleaning action is pre-selected in the Heavy Duty and Whitest Whites cycles. When these cycles are selected, the CATALYST option light glows. If CATALYST cleaning action is not desired, you may cancel any time before Start is pressed.
 - CATALYST cleaning action is automatically added to the Quick Wash and Hand Wash cycles to help ensure the best cleaning results. The CATALYST option light does not glow until after Start is pressed.
- NOTE:** CATALYST cleaning action cannot be cancelled in the Quick Wash and Hand Wash cycles.
- The CATALYST option can be added to any wash cycle.
8. (OPTIONAL STEP) To add an extra Rinse and Spin or an extra Spin only to a wash cycle, press On/Off until the desired option glows.

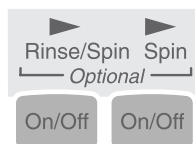

To select a Rinse and Spin only or a Spin only, see “Selecting Options.”

9. (OPTIONAL STEP) The End of Cycle Signal is helpful when you are washing items that should be removed from the washer as soon as the cycle ends.

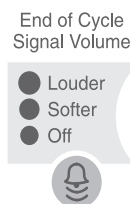

Press the Bell to select a Softer or Louder signal or to turn the End of Cycle Signal Off.

10. Press Start. The wash cycle begins. The total cycle time (in minutes) glows in the Estimated Time Remaining display.



NOTE: If you do not press Start within 5 minutes of selecting the cycle, the cycle and settings are automatically cancelled.

Pausing or restarting your washer

To pause the washer at any time, press Pause/Cancel once.



To restart the washer and resume the wash cycle, press Start.

Changing or Cancelling Cycles and Options

The cycles and options (CATALYST cleaning action, Soak, Rinse/Spin or Spin) may be changed any time before Start is pressed. A single short tone will sound when a selection is made. If an unavailable combination is selected, three short tones will sound and the last selection will not be accepted.

The options can be changed any time after Start is pressed and before the start of the selected option. Follow the progress of your wash cycle with the Washing Status indicator lights.

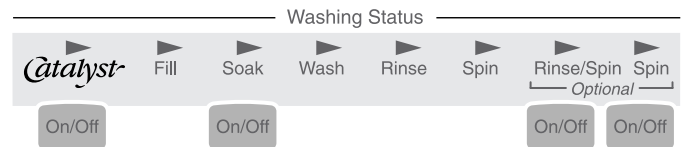

To change an option after the cycle has started

1. Press Pause/Cancel once.
2. Select the desired option.
3. Press Start to resume the cycle.

To cancel a cycle

1. Press Pause/Cancel twice.
2. Select desired wash cycle.
3. Select options.
4. Press Start to restart the washer at the beginning of the new cycle.

Selecting a Cycle

This section describes the available wash cycles and will help you make the best cycle selections for your wash loads. Each cycle is designed for different types of fabric and soil levels. Preset cycle settings provide the recommended fabric care for your selected cycle.

For improved fabric care at water levels below medium, the washer automatically lowers the agitation speed. This change takes place in all cycles except Extra Delicate and Hand Wash. For most loads, use the soil level (agitation time) recommended in the preset settings.

- Select more time for heavy soils and sturdy fabrics.
- Select less time for light soils and delicate fabrics.
- The washer pauses briefly throughout each cycle. These pauses are normal. Refer to “Normal Sounds” to learn more about the sounds you may hear during a wash cycle.
- Refer to “Understanding Washer Cycles” to learn what happens during a wash cycle.

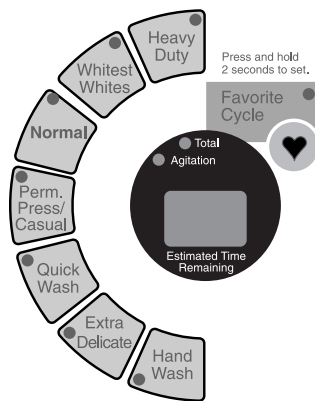

Heavy Duty

Use this 10-15 minute wash cycle for sturdy, colorfast fabrics such as work clothes. The cycle combines high speed agitation and high speed spin, to shorten drying times. This cycle also includes CATALYST® cleaning action to help ensure removal of heavy soils and stains. The preset agitation time is 15 minutes.

Whitest Whites

Use this 10-15 minute wash cycle for loads of white fabrics that need improved whitening. The cycle combines high speed agitation and high speed spin, to shorten drying times. This cycle also includes CATALYST cleaning action, hot wash water and an automatic second rinse. Bleach is recommended in this cycle to provide outstanding whitening. The preset agitation time is 12 minutes.

Normal

Use this 8-12 minute cycle for moderately soiled cottons and linens. The cycle starts with high speed agitation for deep cleaning, then automatically steps to a lower speed to help ensure gentle fabric care. High spin speed shortens drying time. The preset agitation time is 10 minutes.

Perm. Press/Casual

Use this 6-10 minute cycle for cleaning lightly to moderately soiled casual business clothes, permanent press blends and synthetic fabrics. The cycle uses low speed agitation for thorough cleaning and gentle fabric care for your no-iron fabrics. To minimize wrinkling, this cycle features a cool down rinse and a low-speed final spin. The preset agitation time is 8 minutes.

Quick Wash

Use this 4-8 minute cycle for small, lightly soiled loads that need refreshing. CATALYST cleaning action is automatically added to this cycle to help ensure the best cleaning results. For the fastest cycle, select a small load size and less soil level. The preset agitation time is 6 minutes.

Extra Delicate

Use this 4-8 minute wash cycle for sheer fabrics and lingerie. The cycle features extra low speed agitation followed by a deep rinse and a low speed spin. The preset agitation time is 6 minutes.

Hand Wash

Use this 4-8 minute cycle for hand washable garments. The cycle features a series of brief, low speed agitations and short soaks to gently clean special-care items. CATALYST cleaning action is automatically added to this cycle to help ensure the best cleaning results. Low spin speeds minimize wrinkling. The preset agitation/soak time is 6 minutes.

NOTE: Wash small loads. If items appear to be floating (due to trapped air), pause the washer by pressing Pause/Cancel once. Push items down into the washer. Press Start.

Favorite Cycle

Favorite Cycle allows you to customize a favorite cycle and store it for future use.

To store a Favorite Cycle

1. Select a cycle. If desired, change the preset cycle settings.
2. Select options.
3. Press and hold the Heart about 2 seconds until it beeps and the Favorite Cycle light glows.
4. Press Start.

To reuse Favorite Cycle

1. Press the Heart.
2. Press Start.

Preset cycle settings

Your washer has preset soil levels, load sizes and water temperatures based on the cycle selected. The preset settings provide the recommended fabric care for your load. See chart.

Cycle	Soil Level	Load Size	Water Temperature
Heavy Duty	More	Super Plus	Warm/Cold
Whitest Whites	Normal	Super Plus	Hot/Cold
Normal	Normal	Super Plus	Warm/Cold
Perm. Press/Casual	Normal	Super Plus	Warm/Cold
Quick Wash	Normal	Medium	Warm/Warm
Extra Delicate	Normal	Medium	Warm/Cold
Hand Wash	Normal	Medium	Cold/Cold
Soak	Normal	Super Plus	Warm/Cold
Rinse/Spin	None	Super Plus	Warm/Cold

To change the preset cycle settings

Press the Select pad of each setting until the desired setting glows.

Selecting Options

You can customize your wash cycle by adding one or more of the following options to your wash: CATALYST® cleaning action, Soak, Rinse/Spin or Spin.

- A single tone sounds when a selection is accepted.
- Three short tones sound if an unavailable selection is made.

CATALYST® Cleaning Action

Your washer uses CATALYST cleaning action to help ensure better soil and stain removal from your wash load. CATALYST cleaning action reduces the need for pretreatment and is safe for all fabrics. CATALYST cleaning action is pre-selected in the Heavy Duty and Whitest Whites cycles and is automatically added to the Quick Wash and Hand Wash cycles. The CATALYST option can be added to any wash cycle.

How CATALYST cleaning action works

1. Before agitation begins, detergent is automatically released into a special chamber that mixes the detergent with a small amount of water to create a sudsy cleaning solution.
2. Spinning spreads out the clothes.
3. The cleaning solution showers onto the top of the fabrics. The solution is pulled through the clothes, and the detergent enzymes attach to soils and stains, lifting them away.
4. A sensor alerts the washer when the cleaning solution completely penetrates the stains and soils and a rich, sudsy lather covers the clothes. The washer fills to the selected water level and completes the selected cycle.

NOTES:

- For best results, the load should be dry at the start of the cycle.
- Stubborn and set-in stains might require additional pretreatment.

To select or cancel CATALYST cleaning action

Press On/Off to select or cancel CATALYST cleaning action. The CATALYST option must be selected or cancelled before Start is pressed.



Soak

Use Soak for heavy soils and stains that need additional time for removal. You can add Soak to a wash cycle, or you can select a Soak only.

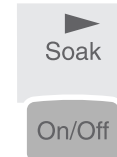

To add Soak to a wash cycle

When Soak is added to a wash cycle, the washer fills to the selected water level, agitates briefly and soaks for a few minutes before the wash cycle begins. The amount of soak time varies with each cycle, but is not longer than 12 minutes.

1. Select a cycle.
2. Press On/Off until the Soak light glows.
3. Press Start.

To select a Soak only

When a Soak only is selected, the washer fills to the selected water level, agitates briefly and soaks. The preset soak time is 30 minutes. If a different soil level is selected, the soak time increases or decreases, depending on the selection. After soaking, the washer agitates briefly, drains and spins. Soak only should be followed by a wash cycle, as there is no rinse.

1. Place a sorted load of clothes into the washer. Add detergent to the detergent dispenser.
2. Press On/Off until the Soak light glows. The preset settings will glow. If desired, change settings.
3. Close washer lid. Press Start.

Rinse/Spin or Spin only

When using extra detergent for heavily soiled clothes, or washing special-care items, you may find an extra rinse and spin is needed. The Rinse/Spin option may also be used for items that need rinsing only or for completing a cycle after a power failure.

An extra drain and spin may help shorten drying times for some heavy fabrics or special-care items by removing excess water. The Spin option may also be used for draining the washer after canceling a cycle or completing a cycle after a power failure.

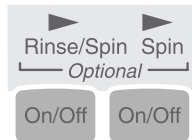

To add an extra Rinse/Spin or Spin to a cycle

1. Select a cycle.
2. Press On/Off until the light glows for the desired option.
3. Press Start.

To select a Rinse/Spin or a Spin only

1. Place a load of clothes into the washer.
2. Press On/Off until the light glows for the desired option.
3. Press Start.

ACCUWASH™ Temperature Control System

Your washer uses ACCUWASH temperature control system. The ACCUWASH feature maintains a uniform water temperature by regulating incoming hot and cold water. This helps eliminate undissolved detergent and ensures consistent cleaning results. The cold wash is regulated at approximately 75°F (24°C). The warm wash is maintained at approximately 100°F (38°C).

When you select a cycle, the washer selects the recommended ACCUWASH setting for the type of fabric and soils being washed.

NOTES:

- Make sure that both hot and cold water faucets are turned on or the ACCUWASH feature will not work properly.
- The wash and rinse water temperature for Hot/Cold are not regulated with the ACCUWASH feature.

The ACCUWASH feature can be turned Off by pressing On/Off.



SMART BLEACH™ Timed Bleach Dispenser

The timed bleach dispenser automatically dispenses liquid chlorine bleach to the wash load at the appropriate time during the cycle to help ensure the cleanest and brightest loads. Bleach is dispensed into the wash load a few minutes after agitation begins in order to give the detergent time to achieve the best soil and stain removal.

NOTE: Do not use this dispenser to add powdered chlorine or color-safe bleach to your wash load. The dispenser is for liquid chlorine bleach only.

Self-Cleaning Lint Filter

Your washer has a self-cleaning lint filter at the bottom of the basket. Wash and rinse water flow over the filter during agitation, separating the lint from the water. The lint spins out of the system during the spin part of the cycle. If your washer drains into a tub, remove any lint collected in the tub or strainer.

WASHER CARE

Cleaning Your Washer

Cleaning the exterior

Use a soft, damp cloth or sponge to wipe up any spills such as detergent or bleach. Occasionally wipe the outside of your washer to keep it looking new.

Cleaning the interior

Clean your washer interior by mixing 1 cup (250 mL) of chlorine bleach and 2 cups (500 mL) of detergent. Pour this into your washer and run it through a complete cycle using hot water. Repeat this process if necessary.

NOTE: Remove any hard water deposits using only cleaners labeled as washer safe.

Cleaning the dispensers

The dispensers are self-cleaning. If the liquid fabric softener dispenser needs cleaning, scrub with a brush using a liquid laundry detergent solution.

IMPORTANT:

- Remove hard water deposits using only cleaners labeled as washer safe.
- Never use any cleaning fluids on dispenser parts. This can cause damage to the plastic.

Water Inlet Hoses

Replace inlet hoses after five years of use to reduce the risk of hose failure. Periodically inspect and replace inlet hoses if bulges, kinks, cuts, wear or leaks are found.

When replacing your inlet hoses, mark the date of replacement on the label with a permanent marker.

Vacation, Storage, and Moving Care

Install and store your washer where it will not freeze. Because some water may stay in the hoses, freezing can damage your washer. If storing or moving your washer during freezing weather, winterize it.

Non-use or vacation care

Operate your washer only when you are at home. If you will be on vacation or not using your washer for an extended period of time, you should:

- Unplug washer or disconnect power.
- Turn off the water supply to the washer. This helps avoid accidental flooding (due to a water pressure surge) while you are away.

To winterize washer

1. Shut off both water faucets.
2. Disconnect and drain water inlet hoses.
3. Put 1 quart (1 L) of R.V.-type antifreeze in the basket.
4. Run washer on a drain and spin setting (see “Selecting Options”) for about 30 seconds to mix the antifreeze and water.
5. Unplug washer or disconnect power.

To use washer again

1. Flush water pipes and hoses.
2. Reconnect water inlet hoses.
3. Turn on both water faucets.
4. Plug in washer or reconnect power.
5. Run the washer through a complete cycle with 1 cup (250 mL) of detergent to clean out antifreeze.

TROUBLESHOOTING

First try the solutions suggested here and possibly avoid the cost of a service call...

Washer displaying code message

- **“LF” (Long Fill)**
Are the water inlet hoses kinked or clogged?
Are the water inlet valve screens clear?
- **“LD” (Long Drain)**
Is the drain hose kinked or clogged?
- **“FF” (Fill Failure)**
There is a problem with the water level sensing system. Call for service.
- **“OL” (Open Lid)**
Is the lid open?
- **“OB” (Off Balance)**
Is the load unbalanced? Redistribute the load.
- **“F” Variables (F1, F2, ...F9)**
A washer operation failure has occurred. Do the following:
 1. Press Pause/Cancel twice.
 2. Open and close the washer lid.
 3. Reset the cycle and press Start.If the problem persists, press Pause/Cancel twice to clear the display. Call for service.

Washer won't fill, rinse or agitate

- **Check the following:**
Is the power cord plugged into a grounded 3 prong outlet?
Is there power at the plug? Check electrical source or call electrician.
Are the water inlet valve screens clogged?
Are the hot and cold water faucets turned on?
Is the water inlet hose kinked?
Is there oversudsing? Spin load; restart cycle. Do not add detergent.
- **Does the water level seem too low, or does the washer appear to not fill completely?**
The top of the agitator is much higher than the highest water level. This creates a perception that the washer is not filling completely. This is normal.

Washer stops

- **Check the following:**
Is the power cord plugged into a grounded 3 prong outlet?
Did you press Pause/Cancel? To restart the washer, press Start.
Are the water inlet valve screens clogged?
Are the hot and cold water faucets turned on?
Is the water inlet hose kinked?
- **Is there power at the plug?**
Check electrical source or call electrician.

- **Has a fuse blown or has the circuit breaker tripped?**
If problem continues, call electrician.
- **Are you using an extension cord?**
Do not use an extension cord.
- **Is the washer in a normal pause in the Perm. Press/ Casual or Hand Wash cycle?**
The washer pauses for about 2 minutes in the Perm. Press/ Casual cycle. Allow the cycle to continue.
The Hand Wash cycle features periods of agitation and soak.
- **Is the washer overloaded?**
Wash smaller loads.

Washer won't drain or spin

- **Is the drain hose clogged, or the end of the drain hose more than 96 in. (244 cm) above the floor?**
See the Installation Instructions for proper installation of drain hose.
- **Is the lid open?**
The lid must be closed during operation.
- **Is there excessive sudsing?**
Always measure detergent. Follow manufacturer's directions. If you have very soft water, you might need to use less detergent.
- **Is your voltage low?**
Check electrical source or call electrician. Do not use an extension cord.

Washer continues to fill or drain, or the cycle seems stuck

- **Is the top of drain hose lower than the water level in washer?**
The top of the hose must be higher than the water level in the washer for proper operation. See the Installation Instructions.
- **Does the drain hose fit too tightly in the standpipe, or is it taped to the standpipe?**
The drain hose should be loose yet fit securely. Do not seal the drain hose with tape. The hose needs an air gap. See the Installation Instructions.

Washer makes noise

- **Is the load balanced and the washer level?**
The wash load should be balanced and not overloaded.

The washer must be level. The front feet should be properly installed and the nuts tightened. Reset the rear leveling legs (if needed). See the Installation Instructions.

Did you completely remove the yellow shipping strap with cotter pins? See the Installation Instructions.
- **Are the gears engaging after the drain and before spin, or is the upper part of agitator clicking during wash?**
These are normal washer noises.

Washer leaks

- **Check the following:**
Are the fill hoses tight? Are the fill hose washers properly seated? Is the drain hose clamp properly installed? See the Installation Instructions.
- **Is the sink or drain clogged?**
Sink and standpipe must be able to handle 17 gal. (64 L) of water per minute.
- **Is water deflecting off the tub ring or the load?**
Center the tub before starting the washer.

The wash load should be balanced and not overloaded. The fill or spray rinses can deflect off the load.

The washer must be level. The front feet should be properly installed and the nuts tightened. Reset the rear leveling legs (if needed). See the Installation Instructions.
- **Check household plumbing for leaks.**

Washer basket is crooked

- **Was the washer basket pulled forward during loading?**
The wash load should be balanced and not overloaded. Push the basket to the center before starting wash.
- **Is the load balanced and the washer level?**
The wash load should be balanced and not overloaded.

The washer must be level. The front feet should be properly installed and the nuts tightened. Reset the rear leveling legs (if needed). See the Installation Instructions.
- **The washer basket moves while washing.**
This is normal.

Agitator operation

- **The top of the agitator is loose, or moves in only one direction.**
This is normal.

Dispensers clogged or bleach leaking

- **Did you follow the manufacturer's directions when adding detergent and fabric softener to the dispensers?**
Measure detergent and fabric softener. Carefully pour into the dispensers. Wipe up all spills.

Dilute fabric softener in the fabric softener dispenser.
- **Did you put powdered or liquid, color-safe bleach in the liquid chlorine bleach dispenser?**
Add powdered or liquid color-safe bleach to the detergent dispenser. Do not use the chlorine bleach dispenser for color-safe bleach.

Load too wet

- **Did you use the right cycle for the load being washed?**
Select a cycle with a higher spin speed.
- **Did you use a cold rinse?**
Cold rinses leave loads wetter than warm rinses. This is normal.

Residue or lint on load

- **Did you sort properly?**
Sort lint givers (towels, chenille) from lint takers (corduroy, synthetics). Also sort by color.
- **Did you overload the washer?**
The wash load must be balanced and not overloaded. Lint can be trapped in the load if overloaded. Wash smaller loads.
- **Check the following:**
Was paper or tissue left in pockets?

Did you use enough detergent? Follow manufacturer's directions. Use enough detergent to hold the lint in the water.

Is your water colder than 70°F (21°C)? Wash water colder than 70°F (21°C) may not completely dissolve the detergent.

Stains on load

- **Did you follow the manufacturer's directions when adding detergent and fabric softener?**
Measure detergent and fabric softener. Use enough detergent to remove soil and hold it in suspension.
- **Did you add fabric softener directly to the load?** Use your fabric softener dispenser, if available. Do not drip fabric softener on clothes.
- **Is there above average iron (rust) in water?**
You may need to install an iron filter.
- **Did you properly sort the load?**
Sort dark clothes from whites and lights.
- **Did you unload the washer promptly?**
To avoid dye transfer, unload the washer as soon as it stops.

Load is wrinkled

- **Did you unload the washer promptly?**
Unload the washer as soon as it stops.
- **Did you use the right cycle for the load being washed?**
Use the Perm. Press/Casual cycle or another cycle with a low spin speed to reduce wrinkling.
- **Did you overload the washer?**
The wash load must be balanced and not overloaded. Loads should move freely during washing.
- **Was the wash water warm enough to relax wrinkles, or are you using warm rinses?**
If safe for the load, use warm or hot wash water. Use cold rinse water.
- **Are the hot and cold water hoses reversed?**
Check to be sure the hot and cold water hoses are connected to the right faucets. See the Installation Instructions.

Load is tangled or twisted

- **Did you overload the washer?**
The wash load must be balanced and not overloaded. Loads should move freely during washing.
- **Did you wrap items around the agitator?**
Drop items loosely into the washer. Do not wrap items around the agitator.

Gray whites, dingy colors

- **Did you properly sort the load?**
Dye transfer can occur when mixing whites and colors in a load. Sort dark clothes from whites and lights.
- **Was the wash temperature too low?**
Use hot or warm washes if safe for the load. Hot water should be at least 111°F (44°C) to clean heavy soils.
- **Did you use enough detergent, or do you have hard water?**
Use more detergent for washing heavy soils in cold or hard water.
- **Are the hot and cold water hoses reversed?**
Check to be sure the hot and cold water hoses are connected to the right faucets. See the Installation Instructions.

Garment damage

- **Check the following:**
Were sharp items removed from pockets before washing? Empty pockets, zip zippers, snap or hook fasteners before washing.

Were strings and sashes tied to prevent tangling?

Were items damaged before washing? Mend rips and broken threads in seams before washing.
- **Did you overload the washer?**
The wash load must be balanced and not overloaded. Loads should move freely during washing.
- **Did you properly add chlorine bleach?**
Do not pour chlorine bleach directly on load. Use your liquid chlorine bleach dispenser, if available. Wipe up bleach spills. Undiluted bleach will damage fabrics.
- **Did you follow the manufacturer's care label instructions?**

ASSISTANCE OR SERVICE

Before calling for assistance or service, please check "Troubleshooting." It may save you the cost of a service call. If you still need help, follow the instructions below.

When calling, please know the purchase date and the complete model and serial number of your appliance. This information will help Whirlpool Assistance or Service to better respond to your request.

If you need replacement parts

If you need to order replacement parts, Whirlpool recommends that you only use FSP® factory specified parts. These parts will fit right and work right because they are made with the same precision used to build every new WHIRLPOOL GOLD® appliance.

To locate FSP® replacement parts in your area:

In the U.S.A., call the Customer Interaction Center at **1-800-253-1301**, or your nearest Whirlpool designated service center.

In Canada, call **1-800-807-6777**, or your nearest Whirlpool designated service center.

In the U.S.A.

Call the Whirlpool Customer Interaction Center toll free: **1-800-253-1301**.

Our consultants provide assistance with:

- Features and specifications on our full line of appliances
- Installation information
- Use and maintenance procedures
- Accessory and repair parts sales
- Specialized customer assistance (Spanish speaking, hearing impaired, limited vision, etc.)
- Referrals to local dealers, repair parts distributors, and service companies

Whirlpool designated service technicians are trained to fulfill the product warranty and provide after-warranty service anywhere in the United States.

To locate the Whirlpool designated service company in your area, you can also look in your telephone directory Yellow Pages.

For further assistance

If you need further assistance, you can write to Whirlpool Corporation with any questions or concerns at:

Whirlpool Brand Home Appliances
Customer Interaction Center
553 Benson Road
Benton Harbor, MI 49022-2692

Please include a daytime phone number in your correspondence.

In Canada

Call the Whirlpool Canada Inc. Customer Interaction Center toll free:

1-800-461-5681 8:30 a.m. - 5:30 p.m. EST.

Our consultants provide assistance with:

- Features and specifications on our full line of appliances
- Referrals to local dealers

For service in Canada

Call **1-800-807-6777**. Whirlpool Canada Inc. designated service technicians are trained to fulfill the product warranty and provide after-warranty service anywhere in Canada.

For further assistance

If you need further assistance, you can write to Whirlpool Canada Inc. with any questions or concerns at:

Customer Interaction Center
Whirlpool Canada Inc.
1901 Minnesota Court
Mississauga, Ontario L5N 3A7

Please include a daytime phone number in your correspondence.

Gearcase assembly covered by your warranty

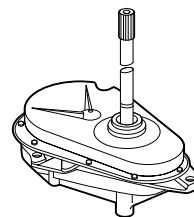

WHIRLPOOL GOLD® WASHER WARRANTY

ONE-YEAR FULL WARRANTY

For one year from the date of purchase, when this washer is operated and maintained according to instructions attached to or furnished with the product, Whirlpool Corporation will pay for FSP® replacement parts and repair labor to correct defects in materials or workmanship. Service must be provided by a Whirlpool designated service company.

FIVE-YEAR LIMITED WARRANTY ON TOP, LID, GEARCASE ASSEMBLY AND ELECTRONIC CONTROL BOARD

For five years from the date of purchase, when this washer is operated and maintained according to instructions attached to or furnished with the product, Whirlpool Corporation will pay for FSP® replacement parts for the following, if defective in materials or workmanship: porcelain top and lid (against chipping and rust); any part of the gearcase assembly; the electronic control board.

TEN-YEAR LIMITED WARRANTY ON OUTER TUB

For ten years from the date of purchase, when this washer is operated and maintained according to instructions attached to or furnished with the product, Whirlpool Corporation will pay for FSP® replacement parts for the outer tub should it crack or fail to contain water, if defective in materials or workmanship.

LIFETIME LIMITED WARRANTY ON WHITE PORCELAIN BASKET

For the lifetime of the washer, when this washer is operated and maintained according to instructions attached to or furnished with the product, Whirlpool Corporation will pay for FSP® replacement parts for the white porcelain basket should it chip or rust due to defects in materials or workmanship.

Whirlpool Corporation will not pay for:

1. Service calls to correct the installation of your washer, to instruct you how to use your washer, or to replace house fuses or correct house wiring or plumbing.
 2. Repairs when your washer is used in other than normal, single-family household use.
 3. Damage resulting from accident, alteration, misuse, abuse, fire, flood, acts of God, improper installation, installation not in accordance with local electrical and plumbing codes, or use of products not approved by Whirlpool Corporation.
 4. Any labor costs during the limited warranty periods.
 5. Replacement parts or repair labor costs for units operated outside the United States and Canada.
 6. Pickup and delivery. This product is designed to be repaired in the home.
 7. Repairs to parts or systems resulting from unauthorized modifications made to the appliance.
 8. In Canada, travel or transportation expenses for customers who reside in remote areas.
-

WHIRLPOOL CORPORATION AND WHIRLPOOL CANADA INC. SHALL NOT BE LIABLE FOR INCIDENTAL OR CONSEQUENTIAL DAMAGES.

Some states and provinces do not allow the exclusion or limitation of incidental or consequential damages, so this exclusion or limitation may not apply to you. This warranty gives you specific legal rights and you may also have other rights which vary from state to state or province to province.

Outside the 50 United States and Canada, this warranty does not apply. Contact your authorized Whirlpool dealer to determine if another warranty applies.

If you need service, first see "Troubleshooting." Additional help can be found by checking "Assistance or Service," or call our Customer Interaction Center at **1-800-253-1301** from anywhere in the U.S.A. or write: Whirlpool Corporation, Customer Interaction Center, 553 Benson Road, Benton Harbor, MI 49022-2692. In Canada, call Whirlpool Canada Inc. at **1-800-807-6777**.

4/00

Keep this book and your sales slip together for future reference. You must provide proof of purchase or installation date for in-warranty service.

Write down the following information about your washer to better help you obtain assistance or service if you ever need it. You will need to know your complete model number and serial number. You can find this information on the model and serial number label/plate, located on your appliance as shown in "Parts and Features."

Dealer name _____

Address _____

Phone number _____

Model number _____

Serial number _____

Purchase date _____

3953949B

© 2002 Whirlpool Corporation.
All rights reserved.

© Registered Trademark/TM Trademark of Whirlpool, U.S.A.,
Whirlpool Canada Inc. Licensee in Canada

1/02
Printed in U.S.A.